



**WACKER  
NEUSON**  
*all it takes!*

## Dumpers

Wheel dumpers, Dual View dumpers, and track dumpers



# Wacker Neuson – all it takes!



## Contents.

### Wheel dumpers

DW15e	4
DW10, DW15	8
DW20, DW30, DW40	12
DW50	22
DW60, DW90	26

### Dual View Dumpers

DV45	18
DV60, DV90, DV100	30
DV125	36
Active Sense Control (ASC)	40

### Skip and platform versions

42

### Configuration options, dimensions, technical data

43

### Track dumpers

DT05e, DT10e	52
DT05, DT08, DT10, DT12, DT15, DT23	54

### Skip and platform versions

56

### Configuration options, dimensions, technical data

58

#### Invest in the future.

With Wacker Neuson you are set on high-quality construction machines and equipment on which you can rely for decades – with a consistently high resale value. With over a 75 year history we are building on a strong foundation and we are proud of innovations, which have revolutionized the entire industry. Innovation is in our DNA – benefit from this and prepare yourself for the future.

Experience more:  
[wackerneuson.com](https://www.wackerneuson.com)



#### Rely on an equal-footing partnership, near to you.



Our global network of sales and service stations makes Wacker Neuson a partner with whom you can collaborate on-site on an equal footing. We are there to listen to you, to understand you, and solve your problems with you. Set your sights on a strong partner who will help you to sit ahead of the competition.

#### Bring even more efficiency to your construction site.

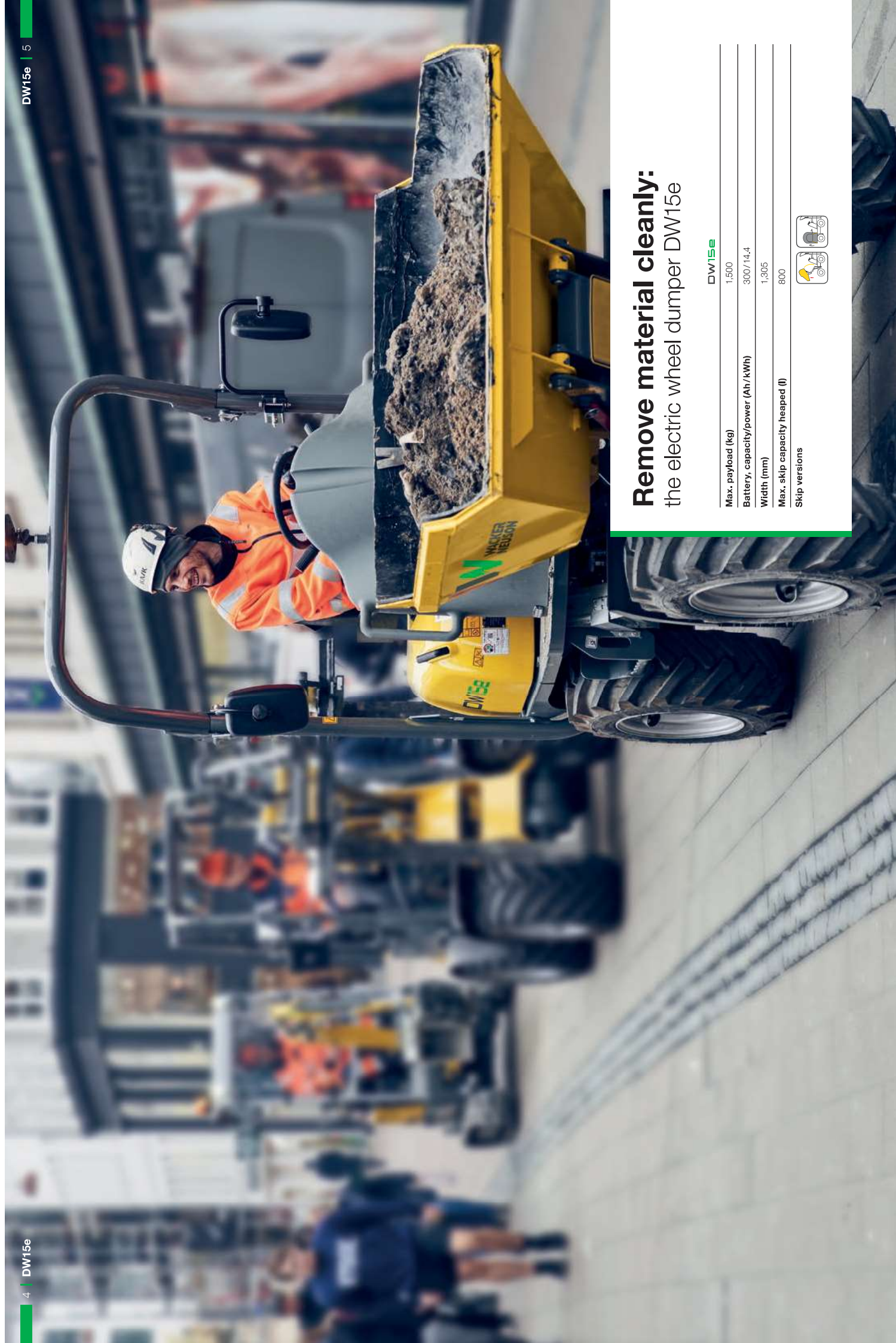
Wacker Neuson guarantees to maximize productivity and minimize the costs – with high-quality products, reliable solutions, and support, which guarantees a smooth construction site operation all the time.



## Remove material cleanly: the electric wheel dumper DW15e

DW15e	
Max. payload (kg)	1,500
Battery, capacity/power (Ah/kWh)	300/14.4
Width (mm)	1,305
Max. skip capacity heaped (l)	800
Skip versions	 

## Electric wheel dumper DW15e: transport material completely emission-free.



### Electric drive system.

Simply start and drive away, thanks to the electric drive system, no frequent gear shifting is needed and the operator can focus on his task. The drive system and the working hydraulics can be operated independently of each other.

### Entry and exit on both sides.

The entry and exits on both sides are very practical and allow the operator to start-up or shutdown the machine in any position. The 3-point contact contributes additionally to the safety of the operator.



### Unlimited performance.

The electric drive system is as good as a traditional drive system with a diesel engine. In addition to this, the machine has very low noise emissions due to the e-drive system. As a result, there are new application areas available in emission-sensitive environments, like for example, at inner-city construction sites.



### Efficiency

- Drive without shifting gears
- Energy recovery during braking process or driving downhill
- Significantly lower operating costs than conventional machines
- Easy service and maintenance access

### Performance

- Same performance as conventional machines
- Articulated pendulum joint
- All-wheel drive system

### Environmental-friendliness

- No exhaust emissions, very low noise pollution
- Comprehensive end user and environmental protection

### Versatility



- Chargeable at a normal 220 V socket
- Electric drive system

### Comfort

- Entry and exit on both sides
- Battery charger on the machine



## Compact, safe and versatile: the new wheel dumpers DW10 and DW15

	DW10	DW15
Max. payload (kg)	1,000	1,500
Engine output (kW/hp)	18.9/25.7	18.9/25.7
Width (mm)	1,194	1,314
Max. skip capacity heaped (l)	525	800
Skip versions	  	

## Wheel dumpers DW10 and DW50: all-rounders with many functions.



### High and swivel tip skip.

The high swivel tip skip makes it possible to empty material, even from a higher range or over obstacles. With the 180-degree swivel function, the swivel tip skip can be emptied in any desired direction, which is particularly useful in tight or less accessible spaces. In addition to this, the swivel tip skip saves time and improves construction site safety, as less maneuvering is required.



### Small dimensions.

The very compact dimensions of both machines enable the flexible and efficient application of the dumper, above all in tight and restricted spaces. Tight passages, narrow paths or areas with a restricted provision of space can both be easily passed, unlike when using a larger machine. Additionally, the compact size makes transportation of the dumper from one construction site to the next easier.



### Articulated pendulum joint.

Due to the articulated pendulum joint, the machine provides great benefits in terms of off-road capability and stability. As a result of this joint, the dumper can be flexibly maneuvered around obstacles and remain sturdy on uneven or more challenging terrain. The articulated joint ensures that the front and rear axles work independently of one another, which improves traction and reduces the risk of tipping over.



### Hydrostatic 4-wheel drive.

Through the application of hydraulics, performance is both equally and continuously distributed across all four wheels, which enables the precise control and adaptation to different ground conditions. This ensures optimal traction on slippery or uneven terrain and reduces the risk of the wheels spinning. In addition to this, there is no longer a need to shift gears, which makes operation particularly comfortable.

### Safety

- Flat and safe mounting and alighting
- Handles are easily accessible and in the signal color
- Hill-hold function
- Skip and tilt monitoring
- Seat belt monitoring incl. optional start release
- Green rotating beacon in conjunction with an orange safety belt
- Increased stability

### Efficiency

- Hydrostatic 4-wheel drive
- Very compact dimensions
- Auto-stop function
- LED work lights
- Intuitive joystick operation
- Very good all-round visibility
- Wide and narrow version (DW10)



### Comfort

- High operating comfort
- Joystick operation
- Plenty of legroom
- Clear operational design
- Seat heating

### Performance

- Hydrostatic 4-wheel drive
- Optional turf tires available
- High or swivel tip skip available (DW15)
- Plenty of ground clearance
- Very good off-road capability
- Towing device incl. socket



## Material transport made easy: the wheel dumpers DW20, DW30, DW40

	DW20	DW30	DW40
Max. payload (kg)	2,000	3,000	4,000
Engine output (kW)	18,9	18,9/36	36
Width (mm)	1,497	1,730	1,780
Max. skip capacity heaped (l)	1,500	1,800	2,300

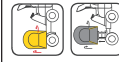

Skip versions

**Even safer. Even more comfortable.**  
An overview of the DW20, DW30, and DW40 features.

### Versatility

- Optional high swivel tip skip (DW20, DW30)

### Safety

- Hydrostatic 4-wheel drive
- Cameras incl. washing system in both directions of travel
- Tilt and skip monitoring
- Seat belt monitoring
- Hill-hold function
- Automatic brake lights with the hydrostatic braking function

### Performance

- Articulated pendulum joint
- Gradeability 50%
- Cruise control (DW30, DW40)

### Comfort

- Clearly arranged instrument panel with joystick operation
- ROPS bar with gas-pressure damper or spacious cabin (DW30, DW40)
- A lot of legroom and storage options
- Entry and exit on both sides (even possible in signal color)
- Heated, imitation leather seat

### Maintenance

- Easy service and maintenance access
- Extended maintenance intervals
- Lockable toolbox on both sides

### Efficiency

- Small dimensions
- High ground clearance
- Continuous speed up to 25 km/h (15.5 mph)
- Auto-stop function



**Wheel dumpers DW20, DW30, DW40:**  
high level of comfort, maximum safety, and intuitive operation.



#### Spacious, comfortable cab.

The optional cabin of the DW30 and DW40 provides a pleasant and safe working environment in any weather. As a result of the extensive range of equipment and a variety of available options, the operator has the option of a comfortable all-round package.

#### Extended maintenance intervals.

The long maintenance intervals of 500 operating hours make additional cost savings possible due to fewer service and maintenance intervals divided over the entire use.



#### Hydrostatic 4-wheel drive.

With the hydrostatic 4-wheel drive, the operator can concentrate on his work without frequent gear shifting. A continuously constant tractive force from zero to the maximum

speed and a hydrostatic brake provide for a comfortable driving experience. An automatic ECO mode is also available for the DW40 wheel dumper.



#### Sturdy skip guard.

The skip guard protects the operator and the cab from falling material. It provides for additional safety even during loading. The protective skip guard was designed and tested for this, based on ISO 10262, front protective grating Level 2.



#### Tilt and skip monitoring.

The installed tilt monitoring provides visual and acoustic notification when there is an insecure status when operating the skip. The skip monitoring reduces the speed of the machine if the skip is not in the starting position.



#### Auto-stop function.

The built-in auto-stop function turns the machine off automatically after five minutes without use. This period of time can be adjusted and the operator is notified visually and acoustically before switching off. As a result, both the engine running time and the exhaust emissions are reduced.



#### Nothing that you can't see.

Cameras in all travel directions with washing systems, additional mirrors and a generous field of vision make every area surrounding the machine optimally visible.



## Dual View becomes Multi View:

the new Dual View Wheel dumper DV45

	DV45
Max. payload (kg)	4,200
Engine output (kW)	36
Width (mm)	1,780
Max. skip capacity heaped (l)	2,400
Skip versions	

## Multi View combines productivity with safety: the new Dual View wheel dumper DV45.



### Multi View mode.

In the Multi View mode, the DV45 can operate sideways with a rotated cabin. As a result, the operator can see the whole working environment to the side and can precisely tip the load to the side on the spot.



### Automatic skip return.

The skip can be automatically returned into the transport position at the press of a button. When retracting the skip, the machine can be operated normally.



### Hydrostatic 4-wheel drive.

With the hydrostatic 4-wheel drive, the operator can concentrate on their work without frequent gear shifting. The automatic ECO mode ensures minimal use.



### Rotating cabin.

The operator cab, which can be rotated up to 180° at the press of a button, enables a comprehensive view around the machine, and greatly increasing safety operator and surrounding environment safety.



### Comfortable cabin.

Storage compartment, incl. cellphone mount, tinted windows with UV protection, large display, optimally arranged control elements, an adjustable armrest and much more, make the wheel dumper DV45 a comfortable everyday hero for the operator.

### Efficiency

- The rotating cabin enables extensive visibility around the machine at the press of a button
- The auto-stop function automatically switches the machine off when not in use
- Multi View mode for optimal visibility when filling to the side

### Comfort

- Intuitive, simple operation with high cabin comfort
- Optional air-conditioning system
- The large, multi-functional 7-inch display ensures a perfect overview of all the machine's functions
- Air-cushioned, heated, comfort seat

### Performance

- Hydrostatic 4-wheel drive with automatic ECO mode
- Variable drive system up to a maximum speed of 25 km/h allows continuous acceleration and braking without shifting gears
- Automatic skip return returns the skip to its starting position at the press of a button

### Safety

- Hill-hold function prevents the machine from rolling away as soon as the foot is taken off of the throttle
- Camera, incl. washing function, front and rear
- Tilt monitoring warns the operators of unsafe use
- Seatbelt monitoring with optional start approval - warns of or prevents start-up when not wearing a seatbelt





## Safety redefined: the wheel dumper DW50

DW50	
Max. payload (kg)	5,000
Engine output (kW)	45/55,4
Width (mm)	1,915
Max. skip capacity heaped (l)	2,650
Skip versions	

**Wheel dumper DW50:**  
optimized for maximum safety and performance.



#### Seatbelt monitoring with seatbelt logic.

Safety is the focus. Therefore, you should not do away with the seatbelt monitoring. The operator must first be seated and buckled up to be able to start the machine. An unsafe start-up is therefore ruled out and more safety for the operator is ensured.



#### Cruise control system.

The cruise control system ensures that the machine maintains a set speed. This way, the operators do not have to concentrate on their speed and can enjoy the comfort of automation.



#### Sturdy skip guard.

The skip guard protects the operator and the cab from falling material – even while driving. It will withstand an impact from an excavator bucket with the maximum force of a 15-ton excavator. The skip protective guard is based on the ISO 10262, and the front protective guard has been designed and tested to Level 2.



#### Performance

- Four-cylinder turbo diesel engine
- Weather protection roof

#### Safety

- Seat belt monitoring
- Sturdy skip guard
- Rear LED lights incl. dynamic turn signals.
- Entry in high visibility color
- Washing system for cameras
- Broadband tone drive signal when activating reverse gear
- Dual-circuit braking system

#### Versatility

- Optional turf tires
- Auto-stop function

#### Efficiency

- Hydrostatic 4-wheel drive with automatic ECO mode

#### Comfort

- Cruise control system
- Lockable storage options in the wheel case
- Heated, imitation leather seat



## Material handling on a large scale:

the wheel dumpers DW60 and DW90

	DW60	DW90
Max. payload (kg)	6,000	9,000
Engine output (kW)	44.5/55.4	55.4
Width (mm)	2,328	2,486
Max. skip capacity heaped (l)	3,500	4,600



## Safe power packages.

An overview of the DW60 and DW90 features.

### Safety

- Sturdy skip guard
- Hill-hold function
- Entry in high visibility color
- Front and rear-view camera with washing system
- Automatic brake lights with the hydrostatic braking function
- Green rotating beacon
- Tilt and skip monitoring
- Seat belt monitoring

### Comfort

- Spacious comfortable cab
- Large, multi-functional display
- Lockable toolbox on both sides
- Laminated safety glass on front and tinted windows to protect the operator

### Performance

- LED front and rear work lights
- Continuous speed up to 25 km/h (15.5 mph)
- Cruise control system

### Efficiency

- Hydrostatic 4-wheel drive with automatic ECO mode
- Joystick operation
- Easy service and maintenance access
- Auto-stop function

## Wheel dumpers DW60 and DW90: efficient load carriers.



### Tilt and skip monitoring.

The tilt monitoring system provides a warning both visually and acoustically if the skip is operated in an insecure state. The skip monitoring system ensures that the machine can only be operated with a limited speed when the skip is lifted.



### Surrounding LED lighting.

The machine is equipped all-round with low-maintenance, powerful headlights from LED work lights to LED rear lights, which can be easily recognized both on and off the road.



### Seatbelt monitoring incl. start release.

The optionally available, intelligent seatbelt monitoring system detects the sequence of sitting down and operating the seatbelt, and will only permit the operator to start the vehicle once they are actually strapped in. A safety belt in signal color and the seatbelt monitoring system are integrated ex works. The installed seat contact switch checks before starting whether the operator has sat on their seat as intended.











### Large, multi-functional display.

The large, multi-functional 7-inch display provides a perfect overview of all the machine's functions and shows the respective camera images. In doing so, the display switches automatically between the image of the front and rear-view camera depending on the input travel direction. This again increases the safety of the machine. Furthermore, the display fulfills the IP69 protective class requirements, making it very sturdy.





## Dumper and truck in one: the Dual View dumpers DV60, DV90, DV100.

	DV60	DV90	DV100
Max. payload (kg)	6,000	9,000	10,000
Engine output (kW)	55/100	55/100	55
Width (mm)	2,230	2,420	2,420
Max. skip capacity heaped (l)	3,500	4,600	5,000
Skip versions	   	  	 

## Highest level of safety thanks to the Dual View.

An overview of the DV60, DV90, and DV100 features.

### Safety

- Sturdy skip guard
- Field of vision is better than the standards
- Spring-loaded parking brake
- Cameras incl. washing function to the front and rear for ideal all-round visibility
- Seatbelt in signal color and green rotating beacon
- Entry in high visibility color
- Automatic brake lights with the hydrostatic braking function
- Seat contact switch
- Tilt monitoring warns the operators of unsafe use
- LED lighting surrounding the machine as standard

### Maintenance

- Very long-life and robust thanks to processing exclusively with high-quality materials
- Lockable toolbox in the wheel case, as standard
- Optimally placed service and maintenance access

### Comfort

- Swivel seat without a center console, therefore more freedom for leg movement and space for the operator
- Storage options and jacket hook for high level of operational comfort
- Cruise control system
- Fold-up armrest for simple entry and exit on both sides
- Spacious, comfortable cabin with optional air-conditioning system
- Clearly arranged instrument panel with joystick operation concept
- Tinted windows with UV protection

### Efficiency

- Optional power version with 100 kW engine for even stronger drive
- Auto-stop function
- Optimally placed service and maintenance access
- Small dimensions
- Hydrostatic 4-wheel drive with automatic ECO mode
- Intuitive joystick operation



### Innovative and safe.

Hill-hold function, tilt monitoring and seatbelt monitoring with start release. The safety of the operator and the surroundings are at the forefront for our machines.



### The Power version.

With the optional Power engine, the Dual View Dumper provides up to 100 kW power and accelerates to up to 30 km/h top speed. With the ECO mode and the auto-stop function, this is also achieved at a higher degree of environmental-friendliness.



### New swivel seat design.

The swivel seat of the new Dual View series has been redesigned in such a way that the rotation is even easier and working is even more comfortable. A lot of leg room and entry & exit on both sides due to a fold-up armrest – the good has just got even better!



### Everything at a glance.

Additional LED lighting as standard and cameras that can be cleaned with an integrated washing system at the press of a button. Therefore, you always have the best all-round view around the machine.



## Dual View Dumper DV60:

Now even more flexible thanks to the skip change system.

### Unrestricted visibility and numerous application options.

The Dual View swivel seat design and the skip change system extend the range of use of the dumper on the construction site many times over. By changing the swivel tip skip to backfill and transporting loose material on a tiltable platform, additional smaller equipment, tools and much more can be transported, if required. In doing so, the platform can also be tilted in three directions and the side walls can be folded down or removed. On fixed substrate, the disconnected skips can be loaded with up to 2 tons' weight. Mounted on the skip, the DV60 offers the option to transport up to 6 tons' payload.



### More operating comfort thanks to the ergonomic swivel console.

Premium steering wheel with tilt adjustment simplifies the safe entry and exit

Rotating assembly mounted on bearings for quick change of the sitting position

Adjustable armrest

Fold-up console for exiting on both sides in both directions of travel

Multi-function display for machine functions, incl. lockable display protection

Screen for standard rear-view camera with lockable anti-vandalism protection; screen and camera fulfill IP69

A lot of legroom with the new swivel seat design



The DV60 skip change system: more options, greater capacity.



### Your dumper. Your rules.

The skip can be disconnected and connected in just a few minutes. With little space required, storage of the stationary skip is not a problem. While 2 tons' materials can be simultaneously stored.



### Effortlessly move more.

Due to the fold-down and detachable side walls, the 3-way side tipping platform can be easily loaded from either side. As a result of the integrated transportation eyelets on the floor and recesses on the underside, it is possible to fix the load.



### All instructions at a glance.

Hydraulic and power connections are perfectly positioned at the operator's height alongside operating instructions affixed onto the machine. As a result, it is possible for a single person to make a change in just a few minutes. The successful coupling and uncoupling is displayed to the operator on the display in the machine.



### Heavy and reliable.

With the help of the feet included in the scope of delivery, the skip can be securely and stably stopped on a fixed subbase. The safety bolts on each foot and the height-adjustable foot extensions ensure for optimal stability.



## Capturing new dimensions: new Dual View dumper DV125

DV125	
Max. payload (kg)	12,500
Engine output (kW)	100
Width (mm)	2,540
Max. skip capacity heaped (l)	7,000
Skip versions	



## Material transport of the next class.

High payload combined with maximum safety.

### Efficiency

- High payload for maximum materials handling
- Compact dimensions and Dual View rotating seat design for optimal maneuverability
- Powerful, even when fully laden, on any terrain
- Tractive force and speed optimally combined
- LED lighting around the machine for use in any weather and at any time of the day
- Auto-stop function

### Comfort

- Cabin with everything that the operator's heart desires
- Air-conditioning, as standard
- Radio incl. Bluetooth hands-free installation and USB charging connections
- Air-cushioned operator's seat, adjustable to the individual operator's weight, incl. heated seat as standard
- Many storage surfaces and lots of legroom

### Safety

- Skip and tilt monitoring
- Skip guard
- Hill-hold function
- Laminated safety glass
- Seatbelt monitoring, optionally incl. start release
- Colored safety belt, combined with green rotating beacon
- Heavy-load axle and reinforced frame

## Larger material volume and safety:

the Dual View dumper DV125.



### A lot helps a lot.

The perfect compromise to combine the benefits of a dumper with the transport volume of a truck. The impressive payload of 12.5 tons makes it possible to transport more material within a shorter time frame. And that is both on the construction site and with road approval.



### Unbelievably efficient.

Simply rotate the seat and drive away. Without time-consuming turning maneuvers it is not only faster in transporting material, but also less restricted in confined spaces. Thanks to the small dimensions and the Dual View operating concept. The operator even has more visibility in the skip direction thanks to the heightened seating position and the camera.



### Safe journey.

The safety standards are in the detail - and in the base model machine. Both the tilt and skip monitoring, as well as hill hold function and skip guard are installed ex works. And these are just a few of the extensive safety features of the base model machine.



### Performance you can rely on.

A powerful engine, reinforced frame, and heavy-load axle ensure that the DV125 can be operated both safely and powerfully on uneven terrain. The hydrostatic 4-wheel drive including braking function, in combination with the articulated pendulum joint generate safety and stability.



### Object detection and integrated braking assistant

- Scans the surroundings for potential obstacles
- Calculates the expected route, even with corners
- Activates before a collision occurs without hindering the daily operation, including emptying and loading\*



\*Empfehlen erfordern ausgearbeiteten Betriebsassistenten

### Active Sense Control (ASC):

Dumper view ahead! Danger averted before it even occurs.



#### Danger assessment deluxe.

All obstacles above the ground are scanned and processed by the machine in real-time using in-house developed software. Should an impact lie ahead, no matter whether it is with an object or a human within the surroundings, the system immediately activates, potentially causing the machine to come to a standstill.



#### Mute mode.

Should the function restrict a desired move, like parking or unloading, it is possible to turn this off short-term. The so-called Mute Mode allows the operator to perform the desired movement despite warning and stop function, and the machine can continue to move.



#### Functionality always at the forefront.

Immediately after starting the machine, the system notifies of its functioning status. The system checks whether all sensors are working free from defects and immediately highlights to the operator if there is contamination or any faults. As a result, the operator is able to perform the necessary cleaning procedures or maintenance prior to start-up in order to ensure full performance and system safety. In this way, ASC proactively supports the prevention of downtime and ensures that the dumper can optimally react to potential collisions at any time.

Warning: The system is not a substitute to the operator's awareness and their obligations. It is the machine operator's responsibility to prevent an accident from occurring.



#### Trailer operation thought out.

If a trailer is to be towed, the system can be switched to trailer operation, which automatically deactivates the radar to the trailer to avoid a continuous alarm and to ensure undisturbed operation. This function ensures that ASC can be flexibly adjusted to different application conditions without restricting the efficiency and the safety.



# Configuration options.

## Wheel dumpers and Dual View dumpers.

	W75	W70	W75	W70	W65	W60	W55	W50	W45	W40	W35	W30	W25	W20
<b>Paint</b>														
Special paint cab / canopy / ROPS	○	○	○	○	○	○	○	○	○	○	○	○	○	○
Multi-color RAL special paint	○	○	○	○	○	○	○	○	○	○	○	○	○	○
Single-color RAL special paint	○	○	○	○	○	○	○	○	○	○	○	○	○	○
<b>EquipCare</b>														
EquipCare incl. app and PC manager*	○	○	○	○	○	○	○	○	○	○	○	○	○	○
EquipCare DualID	○	○	○	○	○	○	○	○	○	○	○	○	○	○
<b>Tires</b>														
Turf tires	○	○	○	○	○	○	○	○	○	○	○	○	○	○
Tires with tractor tread	●	●	●	●	●	●	●	●	●	●	●	●	●	●
Narrow tires	-	-	-	-	-	-	-	-	-	-	-	-	-	-
Tires with all-round tread	○	○	○	○	○	○	○	○	○	○	○	○	○	○
Wide tires	-	-	-	-	-	-	-	-	-	-	-	-	-	-
<b>Safety</b>														
LED front + rear work lights	-	-	○	○	○	○	○	○	○	○	○	○	○	○
Rear working lights LED	-	-	-	-	-	-	-	-	-	-	-	-	-	-
Side mirror (rear-view mirror)	○	●	●	●	●	●	●	●	●	●	●	●	●	●
Broadband tone reverse alarm	-	○	○	○	○	○	○	○	○	○	○	○	○	○
Active Sense Control (object detection) <sup>o</sup>	-	-	-	-	-	-	-	-	-	-	-	-	-	-
Skip guard	-	-	-	-	-	-	-	-	-	-	-	-	-	-
Entry in high visibility color	-	●	●	●	●	●	●	●	●	●	●	●	●	●
Orange LED rotating beacon	○	○	○	○	○	○	○	○	○	○	○	○	○	○
Green LED rotating beacon	-	○	○	○	○	○	○	○	○	○	○	○	○	○
Orange safety belt	-	○	○	○	○	○	○	○	○	○	○	○	○	○
Front-view camera incl. washing system	-	-	-	-	-	-	-	-	-	-	-	-	-	-
Rear-view camera incl. washing system	-	-	-	-	-	-	-	-	-	-	-	-	-	-
Rear LED light (incl. dynamic turn signal)	-	-	-	-	-	-	-	-	-	-	-	-	-	-
Seat belt monitoring and start release	-	○	○	○	○	○	○	○	○	○	○	○	○	○
Hill-hold function	-	●	●	●	●	●	●	●	●	●	●	●	●	●
Skip and tilt monitoring	-	○	○	○	○	○	○	○	○	○	○	○	○	○
Spirit level	-	-	●	●	●	●	●	●	●	●	●	●	●	●
<b>Miscellaneous</b>														
Towing device	-	○	○	○	○	○	○	○	○	○	○	○	○	○
Plug receptacle for towing device	○	○	○	○	○	○	○	○	○	○	○	○	○	○
Road lights	-	-	-	-	-	-	-	-	-	-	-	-	-	-
Equipment for road traffic	○	○	○	○	○	○	○	○	○	○	○	○	○	○
Manufacturer confirmation	○	○	○	○	○	○	○	○	○	○	○	○	○	○
Wheel chock	○	○	○	○	○	○	○	○	○	○	○	○	○	○
TUV road approval (DE)	○	○	○	○	○	○	○	○	○	○	○	○	○	○

● Standard ○ Option - not available

\* Available in Germany, Switzerland, Austria, United Kingdom, Sweden, France, Denmark, Norway, Belgium, Ireland, the Netherlands and Luxembourg. Other countries optional.  
<sup>o</sup> The Active Sense Control object detection is supplied ex works with the stop-assistant to guarantee optimal protection. This must be deactivated, if desired.

# Dimensions.

## Wheel Dumpers.

	Unit	DW15E		DW10		DW15	
		High tip skip	Swivel tip skip	High tip skip	Swivel tip skip	High tip skip	Swivel tip skip
<b>A Overall length</b>	mm	3,300	3,214	3,040	3,040	3,300	3,220
<b>B Wheel base</b>	mm	1,755	1,620	1,620	1,620	1,650	1,700
<b>C Tail projection including towing device</b>	mm	746	878	878	810	810	810
<b>D Pivot point of the high tip skip</b>	mm	1,924	1,186/1,755	820/1,685	820/1,685	820/1,685	-
<b>E Dumping distance</b>	mm	375	491	400	400	400	280
<b>F Width of vehicle</b>	mm	1,322	1,194	1,225	1,305	1,305	1,305
<b>G Width of skip</b>	mm	1,234	1,194	1,225	1,260	1,225	1,260
<b>H Overall height of ROPS</b>	mm	2,550	2,585	2,585	2,550	2,585	2,550
<b>I Height of ROPS folded down</b>	mm	1,971	1,804	1,804	1,960	1,804	1,960
<b>J Height of cab</b>	mm	-	-	-	-	-	-
<b>K Height of dumping edge skip tipped</b>	mm	445/1,516	740	545/1,549	370/1,450	370/1,450	680
<b>L Height of skip tipped</b>	mm	1,966/3,038	2,276	1,851/2,883	1,895/2,975	1,895/2,975	2,250
<b>M Height of skip not tipped</b>	mm	1,409/2,479	1,340	1,186	1,345	1,345	1,300
<b>N Dumping distance lateral</b>	mm	-	108	-	-	-	100
<b>O Ground clearance</b>	mm	252	246	246	260	246	260

	Unit	DW20		DW30		DW40		DW50		DW60		DW70	
		Asphalt skip	High swivel tip skip	High swivel tip skip	Concrete skip	Swivel tip skip	Swivel tip skip	Swivel tip skip	Swivel tip skip	Swivel tip skip	Swivel tip skip	Swivel tip skip	Swivel tip skip
<b>A Overall length</b>	mm	3,784/3,813***	3,865	3,755	3,904	4,680	4,680	4,269	4,412	4,554	4,806	4,744	4,729
<b>B Wheel base</b>	mm	1,882	1,882	1,945	1,945/2,090**	2,090	2,090	2,090	2,190	2,485	2,485	2,700	2,700
<b>C Tail projection including towing device</b>	mm	1,041	1,041	1,041	1,039/1,156**	1,156	1,156	1,072	1,241	1,263	1,263	1,263	1,263
<b>D Pivot point of the high tip skip</b>	mm	-	-	1,746	-	-	-	-	-	-	-	-	-
<b>E Dumping distance</b>	mm	481/457***	527	401	482/539**	1,029	1,212	567	616	565	456	446	514
<b>F Width of vehicle</b>	mm	1,497	1,497	1,627	1,730/1,760	1,780	1,780	1,780	1,915	2,230	2,230	2,420	2,420
<b>G Width of skip</b>	mm	1,482/1,121***	1,488	1,482	1,730	1,740	1,740	1,780	1,926	2,328	2,217	2,218	2,486
<b>H Overall height of ROPS</b>	mm	2,738	2,757	2,757	2,778/2,860**	2,880	2,880	2,857	2,783	3,240	3,258	3,258	3,280
<b>I Height of ROPS folded down</b>	mm	1,770	1,770	1,770	1,945	1,945	1,945	1,945	1,944****	2,591	2,591	2,591	2,618
<b>J Height of cab</b>	mm	-	-	2,669**	2,669	2,689	2,689	2,680	-	2,999	2,999	3,081	3,081
<b>K Height of dumping edge skip tipped</b>	mm	910/881***	675	1,174	994	363	363	1,014	1,111	384	1,100	1,153	374
<b>L Height of skip</b>	mm	2,855/2,862***	2,187	3,586	3,082	3,040	3,040	3,288	3,479	2,417	3,639	3,639	2,950
<b>M Height of skip not tipped</b>	mm	1,404/1,588***	1,430	2,053	1,475	1,562	1,698	1,582	1,882	1,828	1,837	1,830	2,003
<b>N Dumping distance lateral</b>	mm	241/263***	290	162	280	830	700	237	253	-	227.5	227.5	-
<b>O Ground clearance</b>	mm	217	217	217	257	257	257	257	282	378	378	378	396

\*\* Data for power version  
 \*\*\* SLE  
 \*\*\*\* Only when handrail and mirror are disassembled, otherwise 2,205 mm

## Dimensions.

Wheel dumpers and Dual View dumpers.

Unit	DV45		DV50		DV90		DV100		DV125	
	Swivel tip skip	Front tip skip	Swivel tip skip	3-way side tipping platform	Front tip skip	Swivel tip skip	Front tip skip	Swivel tip skip	Front tip skip	Swivel tip skip
<b>A Overall length</b>	4,400	4,441	4,700/4,800*	4,757/4,797*	4,622	4,881/4,998*	4,660	4,881/4,998*	5,342	5,342
<b>B Wheel base</b>	2,280	2,485	2,635	2,635	2,700	2,700	2,700	2,700	2,900	2,900
<b>C Tail projection</b> indicating towing device	1,155	1,155	1,157/1,262*	1,157/1,262*	1,157/1,262*	1,157/1,262*	1,157	1,157/1,262*	1,252	1,252
<b>D Pivot point of the high tip skip</b>	–	–	–	–	–	–	–	–	–	–
<b>E Dumping distance</b>	503	581	599	619	674	553	729	553	628	628
<b>F Width of vehicle</b>	1,780	2,196	2,217	2,196	2,420	2,420	2,420	2,420	2,540	2,540
<b>G Width of skip</b>	1,775	2,328	2,217	2,493	2,466	2,453	2,504	2,453	2,519	2,519
<b>H Overall height of ROPS</b>	3,060	3,435	–	–	3,483	–	–	–	–	–
<b>I Height of ROPS</b> folded down	2,363	2,439	–	–	2,473	–	–	–	–	–
<b>J Height of cab</b>	2,841	–	2,926/3,006*	–	2,974/3,054*	–	–	–	–	–
<b>K Height of dumping edge</b> skip tipped	945	368	1,100/1,092*	1,150	365	1,202/1,200*	333	1,202/1,200*	615	615
<b>L Height skip tipped</b>	3,317	2,402	3,631	3,691	2,573	4,010	2,740	4,010	3,659	3,659
<b>M Height skip not tipped</b>	1,634	1,820	1,838	1,898	2,003	2,036	2,073	2,036	2,223	2,223
<b>N Dumping distance lateral</b>	335	–	209/245*	209	–	249/308*	–	–	–	–
<b>O Ground clearance</b>	261	364/362*	364	364	390	390	390	390	388	388

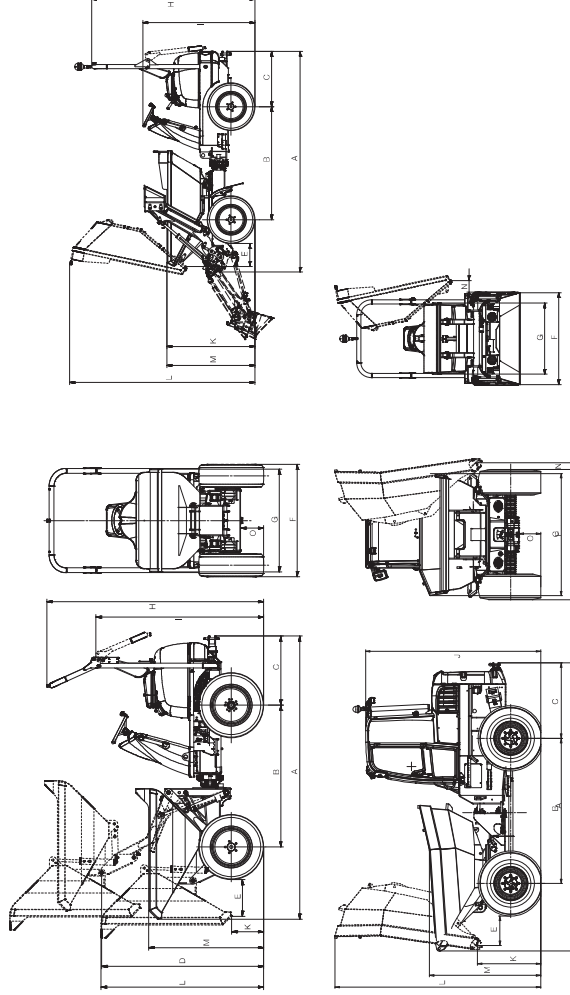

\* Data for power version

## Technical data.

Wheel dumpers and Dual View dumpers.

Unit	DW15E		DW10		DW15	
	High tip skip	Swivel tip skip	High tip skip	Swivel tip skip	High tip skip	Swivel tip skip
<b>General</b>						
Payload	1,500	1,500	1,000	1,000	1,500	1,500
Shipping weight	1,940	1,940	1,215	1,215	1,320	1,261
Skip capacity struck	650	650	415	415	650	650
Skip capacity heaped	800	800	525	525	800	800
Skip capacity volume of water	420	420	280	280	420	325
<b>Drive</b>						
Manufacturer/model	–	–	Yanmar 3TNV76	Yanmar 3TNV76	Yanmar 3TNV76	Yanmar 3TNV76
Design system	–	–	water-cooled 3-cylinder diesel	water-cooled 3-cylinder diesel	water-cooled 3-cylinder diesel	water-cooled 3-cylinder diesel
Power (ISO 3046/1)	kW/hp	6.5	18.9/25.7	18.9/25.7	18.9/25.7	18.9/25.7
Displacement	cm <sup>3</sup>	–	1,116	1,116	1,116	1,116
Operating speed	min <sup>-1</sup>	–	3,000	3,000	3,000	3,000
Emissions / exhaust emission stage	–	100% electric	Stage V	Stage V	Stage V	Stage V
<b>Drive characteristics</b>						
Max. travel speed	km/h	14	15	15	16	16
Articulation	degrees	± 33	± 36	± 36	± 36	± 36
Swing	degrees	± 15	± 15	± 15	± 15	± 15
Turning radius external	mm	3,650	3,000	3,000	3,344	3,344
Theor. gradeability gel.	%	32	48	48	48	48
<b>Drive system</b>						
Drive system	–	4WD electric	4WD Hydrostatic	4WD Hydrostatic	4WD Hydrostatic	4WD Hydrostatic
Standard tires with tractor tread	–	10.0/75–15.3	10.0/75–15.3	10.0/75–15.3	10.0/75–15.3	10.0/75–15.3
<b>Hydraulic system</b>						
Drive pump	–	–	Axial piston pump	Axial piston pump	Axial piston pump	Axial piston pump
Flow rate	l/min	–	84	84	135	135
Operating pressure	bar	–	360	360	360	360
Work pump	–	Gear pump	Gear pump	Gear pump	Gear pump	Gear pump
Flow rate	l/min	16.8	25	25	25	25
Operating pressure	bar	175	170	170	170	170
<b>Tank capacity</b>						
Diesel tank	l	–	15	15	20	20
Hydraulic oil tank	l	20	20	20	20	20
<b>Noise emissions</b>						
Sound power level (L <sub>WA</sub> ) (according to 2000/14/EC)	dB(A)	91	101	101	101	101
Emission sound pressure level (L <sub>PA</sub> )	dB(A)	58	82	82	81	81

# Technical data.

## Wheel dumpers and Dual View dumpers.

Unit	DW20		DW30		DW40		DW50		DW60		DW90		DV45		DV50		DV90		DV100		DV125			
	High Swivel tip skip	Asphalt skip	Swivel tip skip	SLE	High swivel tip skip	Concrete skip	Swivel tip skip	Swivel tip skip	Swivel tip skip	Swivel tip skip	Swivel tip skip	Swivel tip skip	Swivel tip skip	Swivel tip skip	Swivel tip skip	Swivel tip skip	Swivel tip skip	Swivel tip skip	Swivel tip skip	Swivel tip skip	Swivel tip skip	Swivel tip skip	Swivel tip skip	
<b>General</b>																								
Payload	2,254	2,039	2,034	2,389	2,804	3,000	4,000	5,000	6,000	6,000	9,000	4,200	6,000	4,200	9,000	10,000	9,000	10,000	10,000	10,000	12,500	12,500	12,500	
Shipping weight	960	950	950	780	1,280	2,574	2,575	3,106	3,874	4,118	4,478	2,500-3,100	4,700	2,500-3,100	4,500	4,600	4,500	4,600	4,500	4,600	5,900	6,376	6,376	
Skip capacity struck	1,280	1,180	1,280	1,060	1,750	2,000	2,300	2,650	3,150	3,100	4,500	2,400	3,000	2,400	4,800	4,800	4,800	4,800	4,800	4,800	5,000	7,000	7,000	
Skip capacity heaped	700	740	700	630	990	1,200	1,190	1,320	1,600	1,600	2,350	1,350	1,900	1,350	2,400	2,400	2,400	2,400	2,400	2,400	2,550	3,700	3,700	
Skip capacity volume of water																								
<b>Drive</b>																								
Manufacturer/model	Yanmar 3TNV76		Perkins 403J-E17T		Yanmar 3TNV76*		Perkins 403J-E17T		Deutz TD 2.2**		Deutz TD 2.9		Deutz TD 2.9		Deutz TD 2.9/TD 3.6***		Deutz TD 2.9/TD 3.6***		Deutz TD 2.9/TD 3.6***		Deutz TD 3.6***		Deutz TD 3.6***	
Design system	water-cooled 3-cylinder diesel		water-cooled 3-cylinder turbo diesel		water-cooled 3-cylinder diesel		water-cooled 3-cylinder turbo-diesel		water-cooled 3-cylinder turbo-diesel		water-cooled 4-cylinder turbo-diesel		water-cooled 4-cylinder turbo-diesel		water-cooled 4-cylinder turbo-diesel		water-cooled 4-cylinder turbo-diesel		water-cooled 4-cylinder turbo-diesel		water-cooled 4-cylinder turbo-diesel		water-cooled 4-cylinder turbo-diesel	
Power (ISO 3046/1)	18.9/25.7		36/45.3		18.9/25.7		36/45.3		44.5/59.7		55.4/75.3		55.4/75.3		55.4/75.3		55.4/75.3		55.4/75.3		55.4/75.3		100/135.9	
Displacement	1,116		1,663		1,116		1,663		2,200		2,900		2,900		2,900		2,900		2,900		2,900		3,600	
Operating speed	3,000		2,200		3,000		2,200		2,200		2,200		2,200		2,200		2,200		2,200		2,200		2,000	
Emissions/exhaust emission stage	Stage V		Stage V		Stage V		Stage V		Stage V		Stage V		Stage V		Stage V		Stage V		Stage V		Stage V		Stage V	
<b>Drive characteristics</b>																								
Max. travel speed	20		25		20		25		25/30		25		25		25		25		25		25		25	
Articulation	± 36		± 36		± 36		± 36		± 37		± 29		± 29		± 29		± 29		± 28		± 28		± 28,3	
Swing	± 15		± 15		± 15		± 12		± 15		± 11.5		± 11.5		± 11		± 11		± 11		± 11		± 11.5	
Turning radius external	3,800		3,800		3,800		4,030		4,280		6,025		6,750		6,620		6,620		6,620		6,620		7,188	
Theor. gradeability gel.	62		62		62		63		58		58		58		58		58		58		58		50	
<b>Drive system</b>																								
Drive system	4WD hydrostatic		4WD hydrostatic		4WD hydrostatic		4WD hydrostatic		4WD hydrostatic incl. ECO mode		4WD hydrostatic		4WD hydrostatic incl. ECO mode		4WD hydrostatic incl. ECO mode		4WD hydrostatic incl. ECO mode		4WD hydrostatic incl. ECO mode		4WD hydrostatic incl. ECO mode		4WD hydrostatic incl. ECO mode	
Tires - standard	10,00/75-15.3 tractor tread		11.5/80-15.3 tractor tread		11.5/80-15.3 tractor tread		11.5/80-15.3 tractor tread		Mitas 12.5-18 16PR MPT-0/TL		405/770-20 tractor tread		500/60-22.5 tractor tread		500/60-22.5 tractor tread		500/60-22.5 tractor tread		500/60-22.5 tractor tread		500/60-22.5 tractor tread		500/60-22.5 tractor tread	
<b>Hydraulic system</b>																								
Drive pump	Axial piston pump		Axial piston pump		Axial piston pump		Axial piston pump		Axial piston pump		Axial piston pump		Axial piston pump		Axial piston pump		Axial piston pump		Axial piston pump		Axial piston pump		Axial piston pump	
Flow rate	66		66		66		99		123.2		123		123		123		123		123		123		180	
Operating pressure	445		445		445		448		470		500		500		500		500		500		500		473	
Work pump	Gear pump		Gear pump		Gear pump		Gear pump		Gear pump		Gear pump		Gear pump		Gear pump		Gear pump		Gear pump		Gear pump		Gear pump	
Flow rate	33.4		33.4		33.4		30.9		57.86		59		60.6		70		70		70		70		70	
Operating pressure	200		200		200		220		220		240		240		240		240		240		240		240	
<b>Tank capacity</b>																								
Diesel tank	35		35		35		45		60		70		70		80/150***		80/150***		80/150***		80/150***		150	
Hydraulic oil tank	31		31		31		28		39.8		48		48		60		60		60		60		60	
<b>Noise emissions</b>																								
Sound power level (LWA) (according to 2000/14/EC)	101		101		101		101		101		101		101		101		101		101		101		101	
Emission sound pressure level (LPA)	82		81/77***		81		80		81		81		81		81		81		81		81		80	

\* Data for the optional engine; see DW40 \*\* Data for the optional engine; see DW90 \*\*\* Data for the optional engine \*\*\*\* Swivel tip change skip



## Compact, maneuverable, and powerful: our track dumpers

	DT05e	DT10e	DT05	DT08	DT10	DT12	DT15	DT23
Max. payload (kg)	500	1,000	500	800	1,000	1,200	1,500	2,500
Engine output (kW/hp)	5.5/7.5	5.5/7.5	4.9/6.7*	6.8/9.2*	9.7/13.2	12/16.3	15/20.4	18.5/25
Undercarriage width (mm)	680	790	680	790	790	790	1,080	1,300
Max. skip capacity heaped (l)	313**	427	313**	387**	460	460	800*	1,200

\* Diesel version \*\* Front tip skip version

## Electric track dumpers DT05e and DT10e: compact and emission-free.



### Electric drive system.

Simply start and drive away: Thanks to the electric drive system, no frequent gear shifting is required and the operator can focus entirely on their task. In doing so, the drive system and the work hydraulics can be operated entirely independent of one another.

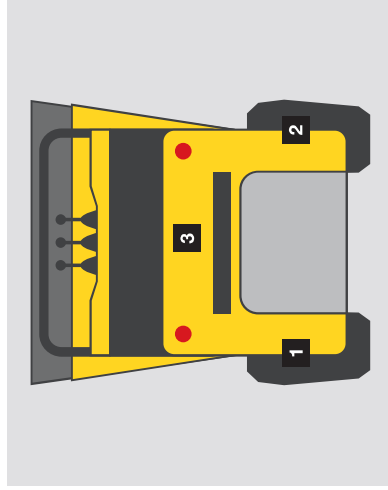

### Three drive motors for 100% electric driving.

One motor per track, as well as for the work hydraulics, which act more efficiently and independent of each other.

- 1 Left motor track
- 2 Right motor track
- 3 Work hydraulics motor

### Battery charger on the machine.

As a result of the charging cable included on the machine, it is possible to charge the machine anywhere and it is usable independent of location. The machine can also be left on the construction site overnight and is immediately ready for use the next day.



### Chargeable at a normal 220 V socket.

With a maximum charging time of 8 hours the machine can simply be connected up to an outlet overnight to fully charge and is ready to use again in the morning with a full battery. The installed charging cable for a 220 V outlet is securely stored in the machine and therefore the machine can be spontaneously charged anywhere.

### Safety

- Lockable engine hood
- High level of traction and gradeability
- Available with front or high tip skip

### Environmental-friendliness

- 100% electric – 0% emissions in application
- Low noise emissions for applications in sensitive environments
- More applications options thanks to the electric drive
- Low service and operating costs

### Maintenance

- Easy service and maintenance access
- Maintenance-free battery

### Efficiency

- Automatic machine switch-off when not in use
- Compact dimensions
- Quick and easy charging at any 220 V socket
- Self-loading equipment for independent loading

DT05e



## Rising to every challenge.

An overview of all the features of our conventional track dumpers:

### Efficiency

- Many skip and platform versions
- Optimal weight distribution
- Small dimensions
- Auto-stop function

### Maintenance

- Easy service and maintenance access
- Long maintenance intervals

### Safety

- Hanging suspension-mounted rollers
- Entry and exit on both sides
- Lockable engine hood
- Wide tracks

### Performance

- Hydrostatic drive system
- Diesel or gasoline engines
- Optional self-loading equipment
- Different engine options: 2-cylinder, 3-cylinder or 4-cylinder (depending on the model)
- Auxiliary hydraulics

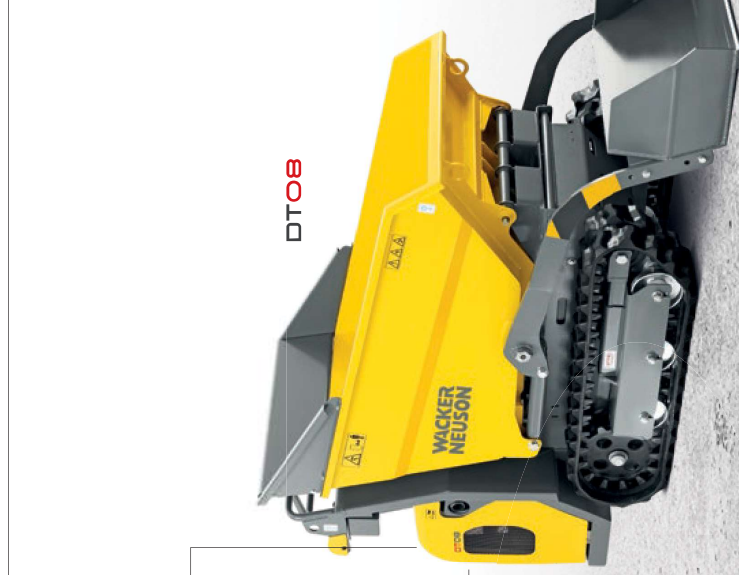

## Our conventional track dumpers: compact construction site aids.



### Hydrostatic drive.

Simply start and drive away, because of the hydrostatic drive system, no frequent gear changing is needed and the operator can focus on the task.



### Diesel or gasoline engines.

Diesel or gasoline engines are available depending on the specifications or requirements.



### Small dimensions and wide tracks.

The compact dimensions of the machine are ideally suited to maneuvering and working in confined spaces. Due to the wide tracks, the machine has a very low ground pressure, whereby the sub-base on which is being worked is only minimally loaded and, as a result, can be treated gently.



### Hanging suspension-mounted rollers.

The suspension-mounted rollers ensure increased running smoothness and safer driving behavior. Due to the hanging mounting, the obstacles and irregularities, like stones, even out. In this way, you also benefit from optimal driving comfort, even under any terrain conditions.

## Skip and platform versions.

Whether for construction sites, gardening and landscaping, or municipal use: The different skip types and platform versions are designed for different needs and provide you with exactly the qualities that are in demand.

### Track dumpers

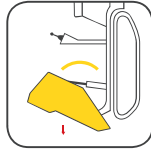

#### Front tip skip

The front tip skip is ideal for when a lot of material has to be transported within a short time.

- For larger volumes of material
- Low center of gravity and low dumping height
- Economical solution

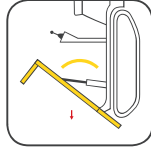

#### Front tip platform

Enlarging the loading area is done in one simple step with the front tip platform.

- Side parts that fold down
- Suitable for pallet transport

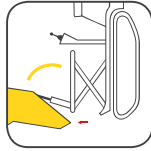

#### High tip skip

The high tip skip bridges height differences when dumping the material.

- Suitable for container loading
- Dumping height of up to 1,963 mm
- Flexible use as front or high tip skip



#### Concrete mixer

If necessary, a track dumper is made into a concrete mixer in a few steps.

- Mixing capacity of 360 l
- Self-loading shovel with 70 l volume

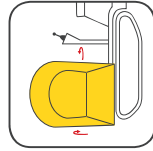

#### Swivel tip skip

The swivel tip skip places material precisely – thanks to the variable 180° tipping.

- Leveling during transport of liquids on gradients
- 2 x 90° swing gear left and right
- Lateral filling possible

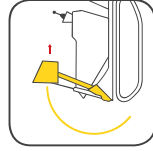

#### Self-loading equipment

Entirely without other machines, lots of material can be filled in a short time with the self-loading equipment.

- Lifting of up to 280 kg material

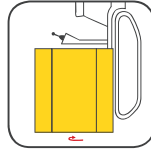

#### 3-way side-tipping platform

The 3-way side-tipping platform offers you the greatest possible flexibility when unloading bulk material.

- Material can be emptied forward or to the side
- Removable side parts
- Suitable for pallet transport

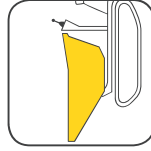

#### Special skips

Additional skip options are available for special applications, such as the light materials trough. Simply ask your specialized dealer.



Front tip skip



Front tip platform



High tip skip



Concrete mixer



Swivel tip skip



Self-loading equipment



# Dimensions.

## Track dumpers.

Fuel	DT12				DT15				DT23		
	Front tip skip	High tip skip	Swivel tip skip	Diesel	Front tipping platform	Front tipping platform	3-way side tipping platform	Swivel tip skip	High tip skip	Concrete mixer	Swivel tip skip
A Length	1,823	1,684	1,960	1,960	1,882	2,565	2,640	2,674	2,609	2,403	3,304
B Length with self-loading system (without running board)	2,277	2,240	-	-	-	3,160	-	-	3,365	3,250	-
C Length of running board	-	393	-	-	-	-	-	-	-	-	-
D Height over running board	-	285	-	-	-	-	-	-	-	-	-
E Undercarriage width	-	790	-	1,080	-	-	-	-	-	-	1,300
F Width of skip	700	764	730	800	1,054	1,054	1,020	1,102	1,000	-	1,312
G Skip length	1,357	1,134	1,427	1,200	1,482	1,482	1,547	1,537	1,500	-	1,945
H Width with self-loading system	830	-	-	-	1,080	-	-	-	1,121	1,080	-
I Track width	-	180	-	230	-	-	-	230	-	-	270
J Track rise length	-	875	-	1,100	-	-	-	-	-	-	1,275
K Height over control console	-	1,280	-	-	-	-	-	-	-	-	-
L Height over skip hand guard	-	-	1,301	-	-	-	-	-	-	926	-
M Concrete mixer width	-	-	-	-	-	-	-	-	-	-	-
N Height over ROPS bar	-	-	-	-	-	-	-	2,372	-	-	2,523
O Height over ROPS bar (collapsed)	-	-	-	-	-	-	-	2,022	-	-	2,163
P Height of skip front edge	812	1,076	1,045	860	770	770	1,150	1,210	1,104	1,254	1,393
Q Tipping height	460	868	650	256	472	472	380/570*	810/614*	873	762	547
R Height of front edge, high tip skip raised	-	1,688	-	-	-	-	-	-	2,193	-	-
S Tipping height, high tip skip raised	-	1,467	-	-	-	-	-	-	1,963	-	-
T Max. height, skip raised	1,950	2,009	2,112	1,430	2,070	2,070	2,040	2,381	2,383	1,647	2,505
U Max. height, high tip skip raised	-	2,610	-	-	-	-	-	-	3,472	-	-
V Tipping angle of the skip	°	70	82	85	56	63	63/53*	84	78	62	85
W Running board retraction angle	°	-	-	14	-	-	-	-	-	-	-
X Ground clearance	mm	175	175	172	160	-	-	224	-	-	160

\* When tipping to the front / side

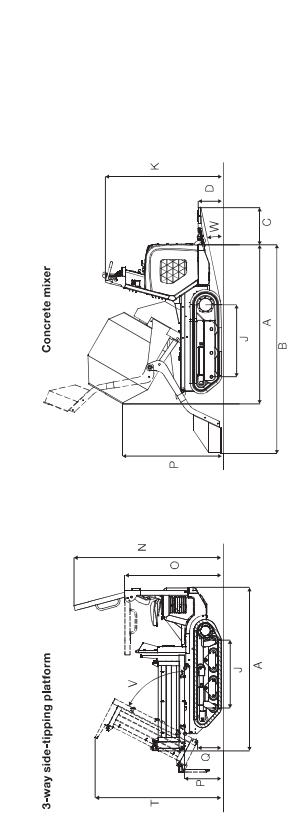
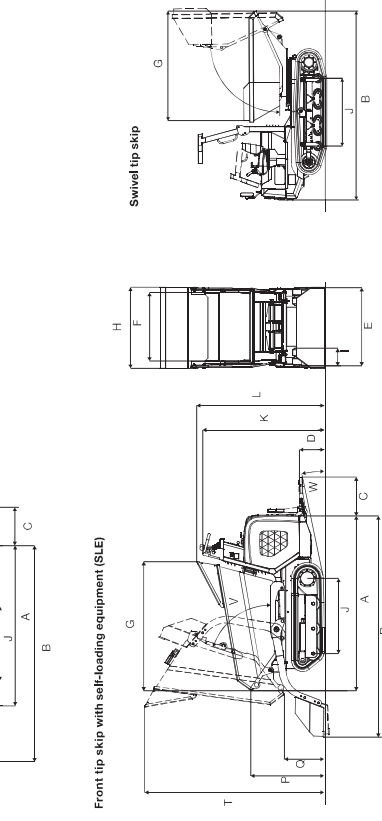
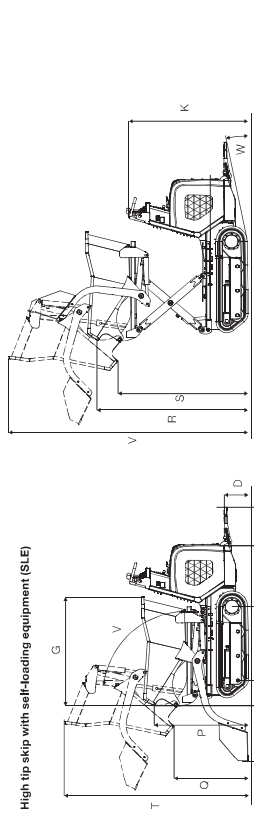



# Wacker Neuson – all it takes.



Concrete technology



Vibratory rammers



Vibratory plates



Rollers



Demolition technology



Generators



Lighting



Pumps



Excavators



Wheel loaders



Telehandlers



Dumpers



Financial solutions



Repair & Maintenance



Academy



EquipCare & EquipCare Pro



Rental



Concrete specialists



eStore



Spare parts



Used machines



ConcreteTec



wackerneuson.com



Facebook  
wackerneuson



Instagram  
@wackerneuson



Youtube  
Wacker Neuson



LinkedIn  
Wacker Neuson



TikTok  
@wacker.neuson



WN-EMEA-10369.V05.EN-US

02/2025 EN